

# AXA Defender

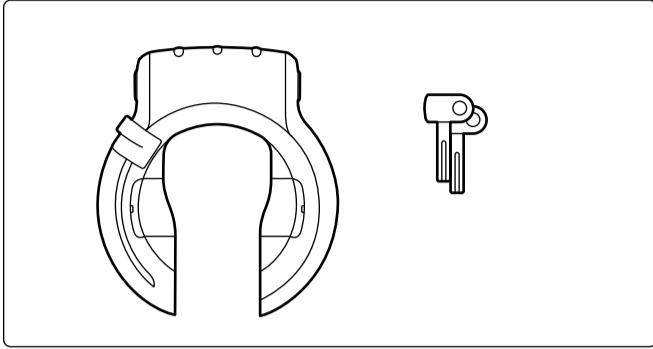

**Content packaging** - Inhoud verpakking - Fourniture - Lieferumfang - Pakkens indhold



**Key service** - Sleutelservice - Service Cles - Schlüssel Service - Nøgleservice

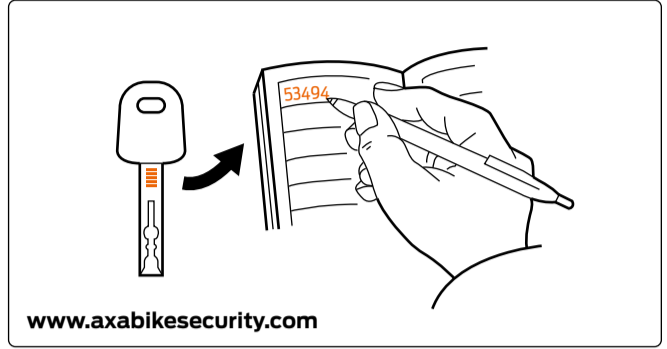

**Mounting options** - Montageopties - Options de montage - Montagemöglichkeiten - Monteringsmuligheder

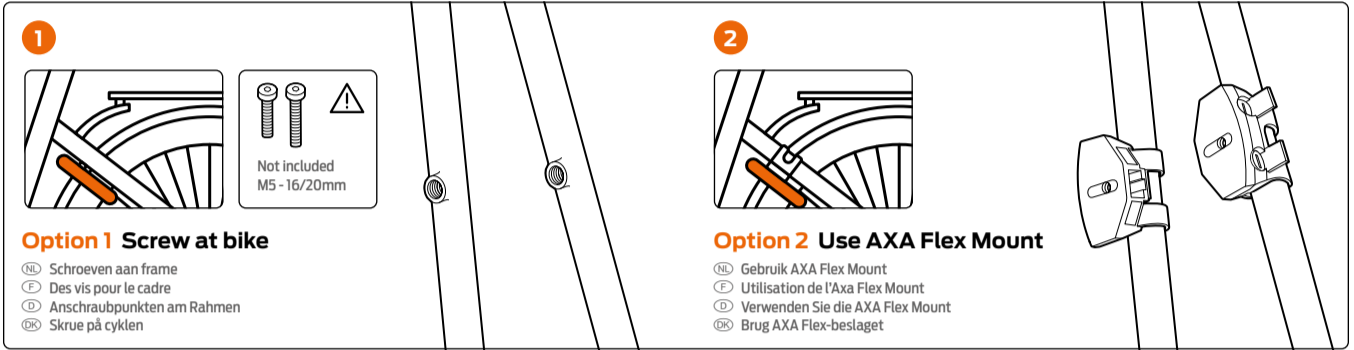

**Mounting** - Montage - Montage - Montage - Montering

\*Not included (NL) Niet inbegrepen (F) Non inclus (D) Nicht enthalten (DK) Medfølger ikke

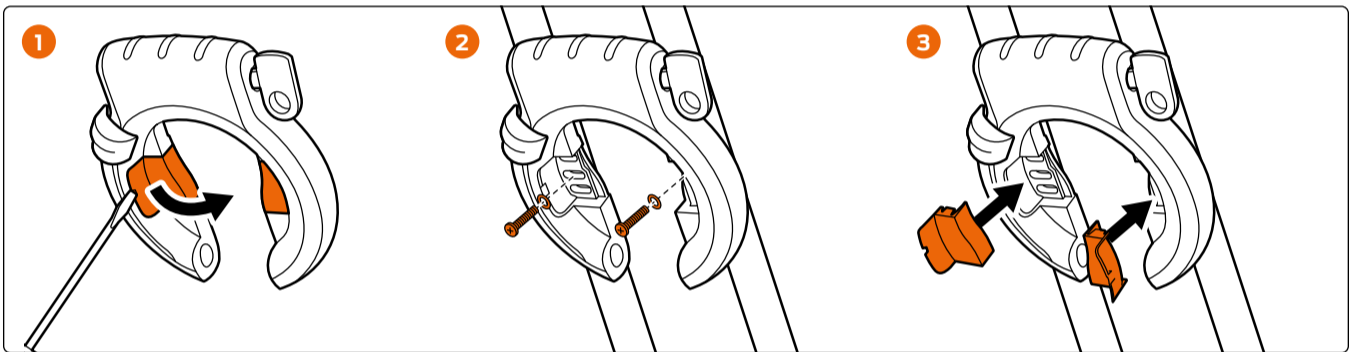

**Operation** - Bedienung - Utilisation - Verwendung - Brug

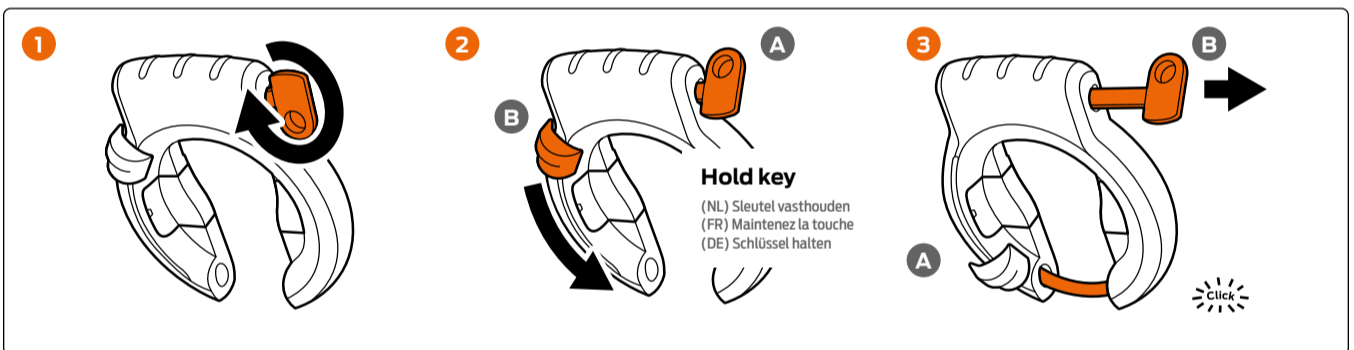

**Insert plug-in cable or chain** - Plug-in kabel of ketting insteken - Insérer un câble ou une chaîne enfichable - Steckkabel oder Kette einführen - Indsæt plug-in-kabel eller -kæde

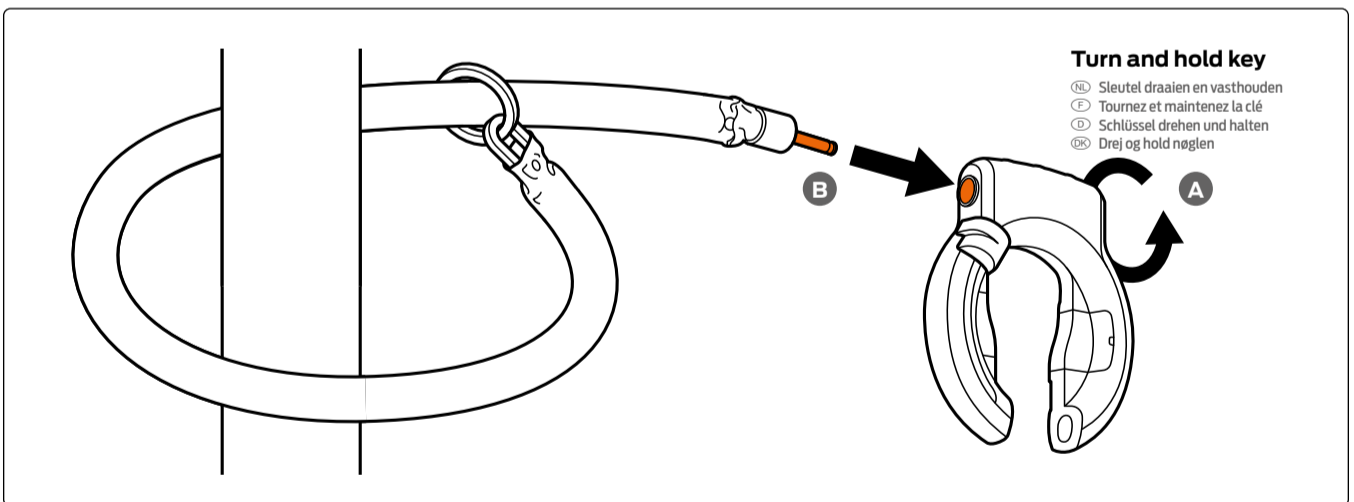

**Maintenance** - Onderhoud - Entretien - Pflege - Vedligeholdelse

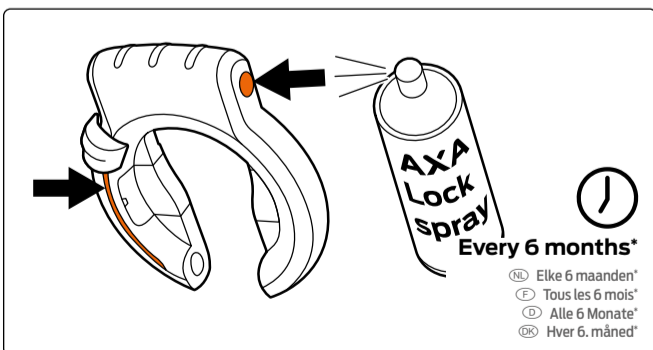

\*Make dust free (NL) \*Stofvrij maken (F) \*Rendre sans poussière (D) \*Staubfrei machen (DK) \*Gør støvfri

**Warranty** - Garantie - Garantie - Garantie - Garanti

AXA guarantees the original buyer a warranty period of 2 years after date of purchase.

- (NL) AXA garandeert de eerste koper een garantietermijn van 2 jaar na aankoopdatum.
- (F) AXA garantit dem Erstkäufer eine Garantie von 2 Jahren nach Kaufdatum.
- (D) AXA garantit l'acheteur original une période de garantie de 2 ans après la date d'achat.
- (DK) AXA giver den oprindelige køber en garantiperiode på 2 år efter købsdatoen.

AXA Bike Security

P.O. Box 47, NL-3900 AA Veenendaal

Phone: +31 (0)318 536 220

axabikesecurity.com



AXA is part of the Allegion family of brands.  
 Product modification reserved.

